

TUB

RIO 700 - 200x90

(with asymmetrical edges)

DATA SHEET



The installation of the tub must be performed by qualified personnel both for regarding the electrical connection than for the hydraulic one.

Before proceeding with the connection the installer must verify that the system electric is protected by a switch differential (0.03) and that the plant of earth complies with current regulations in the country of use.

The hot tub must be connected to the electrical system in a manner fixed (with three-pole H05-3x2.5mm cable with 2.5mm section) through a bipolar switch (minimum opening of 3mm contacts) suitable for power (Kw) of the product to be connected, placed outside the zones 0, 1, 2, 3 and far from possible splash of water.

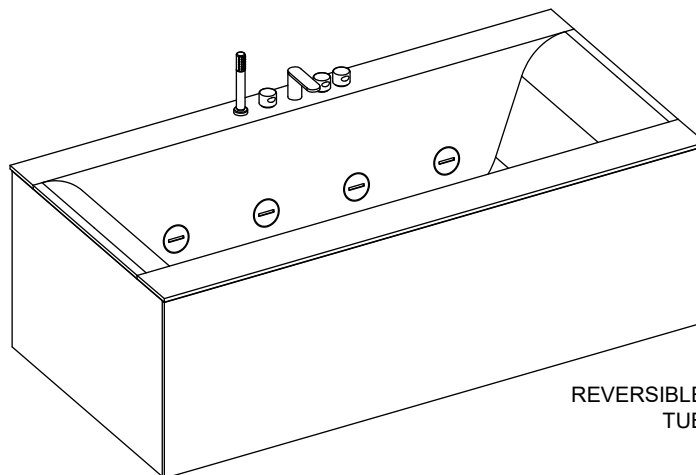

REVERSIBLE TUB

SYSTEM	ELECTRICAL CHARACTERISTICS				BOCCHETTE		CONT. WATER		DIM. PACKING				WEIGHT (KG)	
	Volt	A	W	Hz	Whirl.	Airl.	Use	Max	Length	Width	Height	Volume	Net	Gross
Tub with frame	--	--	--	--	--	--	230 l	390 l	210	100	80	1.7	94	110
Ultra Whirlpool	220-240	10	1500	50/60	8	--	230 l	390 l	210	100	80	1.7	109	125

The data is to be considered without panels and accessories.

The overall dimensions are expressed in centimeters. The actual dimensions can vary by ± 0.5 cm.

The product must also be connected to the equipotential installation of the building using the appropriate terminal on the frame.

In the case of installation of the ad built-in walls, the guarantee will remain valid only if they come provided in the walls themselves, grids of inspection and ventilation to an extent appropriate.

It is also necessary that the tank is removable at any time, without having to resort to interventions on masonry.

WARNING:

In the event of non-compliance, even if only partial, of the conditions indicated therein Bath safety can come compromised: therefore both the guarantee that the responsibility of manufacturer for any direct damage or indirect effects caused by the product. The forfeiture of the guarantee, in the hypothesis above indicated will have as consequences the replacement of only the pieces that will be recognized as defective, without covering the costs derived from the labor required to product removal.

Expect stop taps outside from the bulk of the product to the closing of hot and cold water. If the water pressure is higher as indicated, install reducers of pressure.

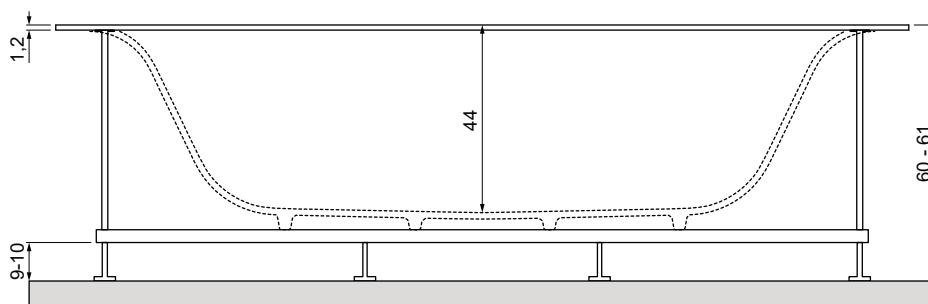
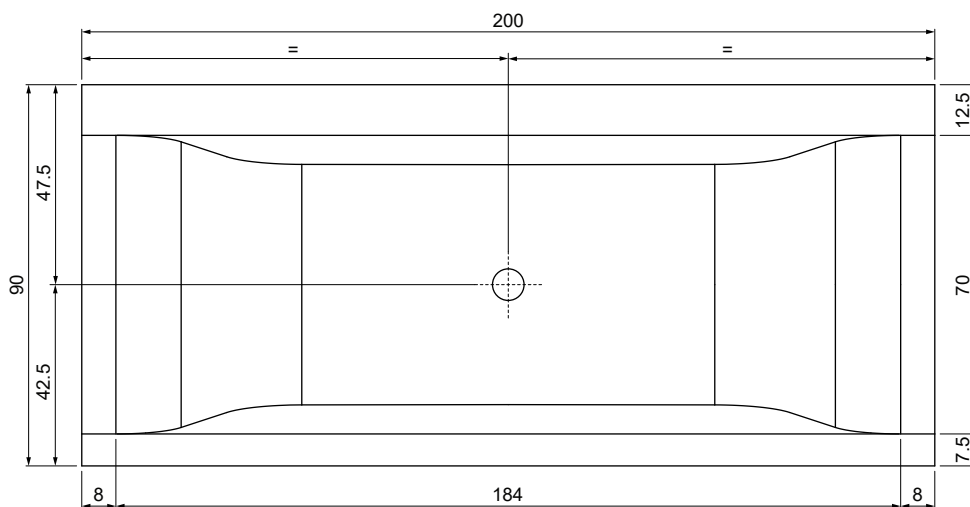

RUBINETTERIA A MURO:

Pay close attention to the height of the tank (60-61 cm) and the width of the edge.

ELECTRICAL AND HYDRAULIC PREPARATION

LEGEND:

A	1/2 "M cold water connection	Predict attacks only with taps by the pool
B	Hot water connection 1/2 "M	
C	Power supply cable type output. H05 - 3 x 2.5 mm (min. Length 2m)	
D	Equipotential cable.	
S	Bathtub drain area Ø 40 mm.	
Y	Inspection area - where provided.	
H	Zone for preparation of connections "A", "B", "C", "D", on the wall (see figure to the side).	



Operating pressure:
- MIN 150 kPa (1.5 bar)
- MAX 300 kPa (3.0 bar)



Hot water temperature:
- MAX 60 ° C (140 ° F)

WARNINGS:

- Do not use a power cord for tubs with a frame.
- In all cases always prepare the cable for the equipotential.

PREPARATION OF ATTACKS "A", "B", "C", "D" ON THE WALL

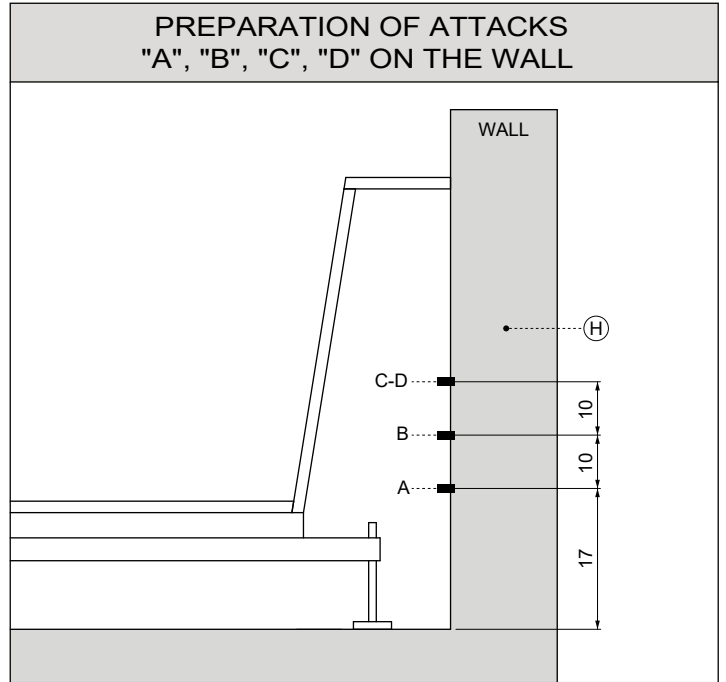

ELECTRICAL AND HYDRAULIC PREPARATION (freestanding version)

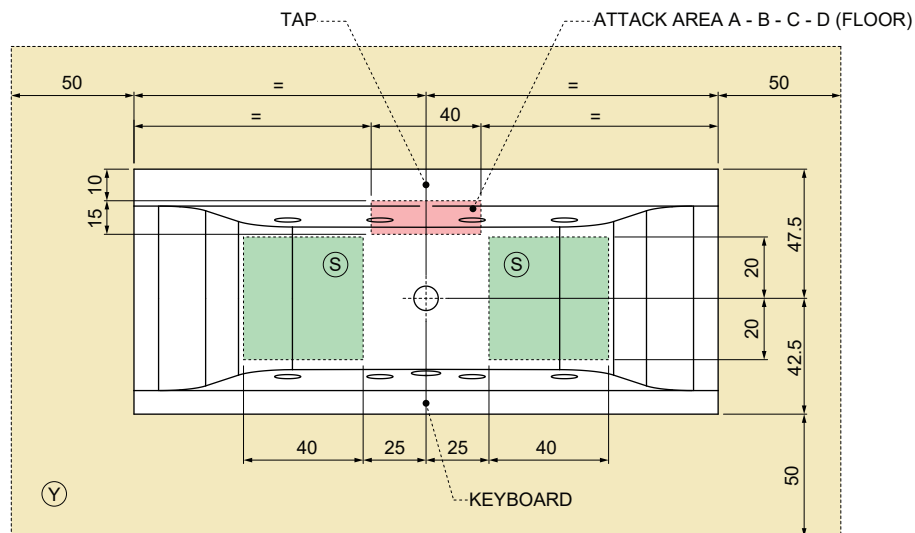

ELECTRICAL AND HYDRAULIC PREPARATION (wall version)

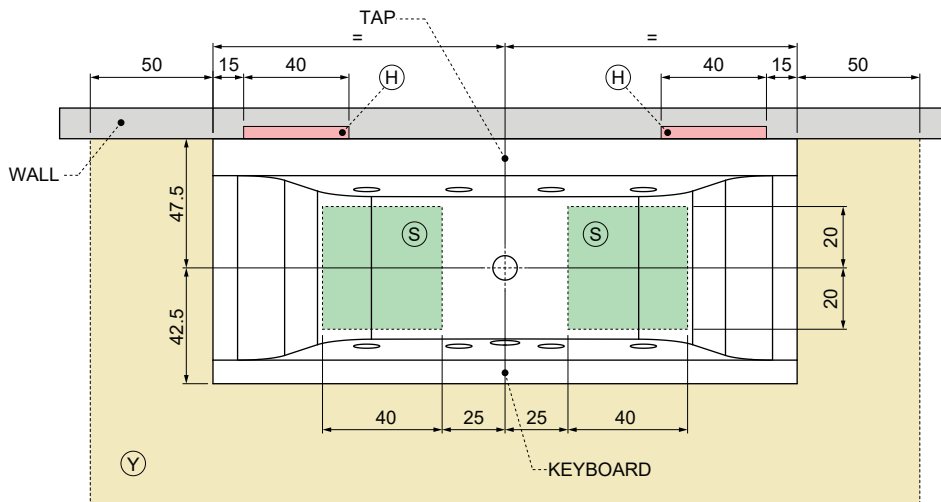

ELECTRICAL AND HYDRAULIC PREPARATION (corner version)

LH ANGLE

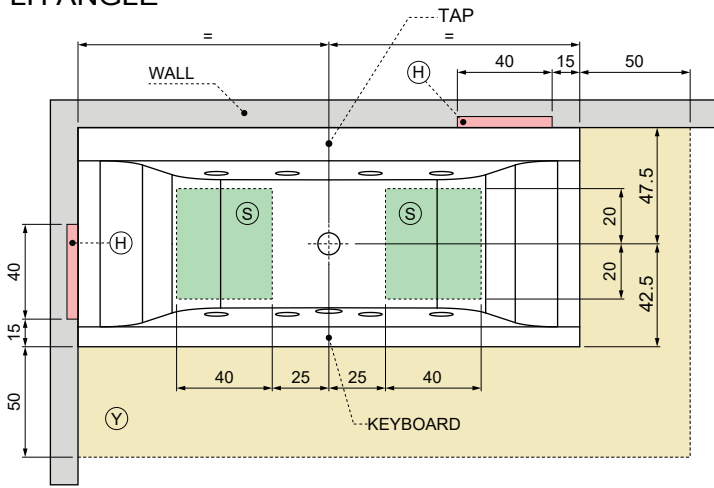

RH ANGLE

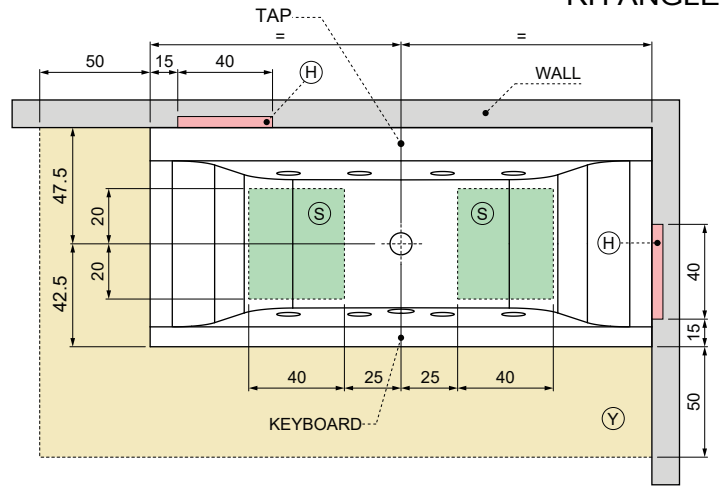

ELECTRICAL AND HYDRAULIC PREPARATION (niche version)

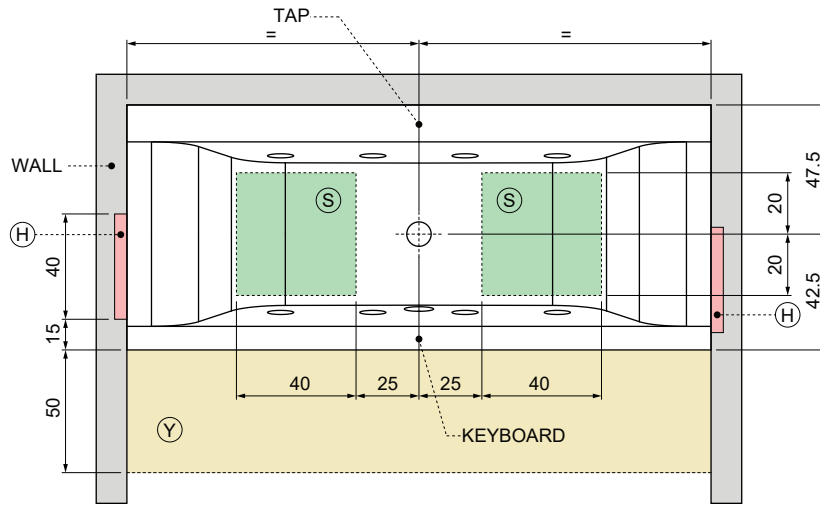

ELECTRICAL AND HYDRAULIC PREPARATION (built-in version)

WARNINGS:

- Proper ventilation is required with a min. \varnothing 15cm.
- The hole for the collection of the bathtub must not be more than 1cm from the outer edge.
- Plan the inspection panel.
- The tank must be removable at any time, without having to resort to it to interventions on the walls.
- Provide a \varnothing 40mm safety drain inside the "pit" for any water leaks. Predict the discharge near the inspection areas.

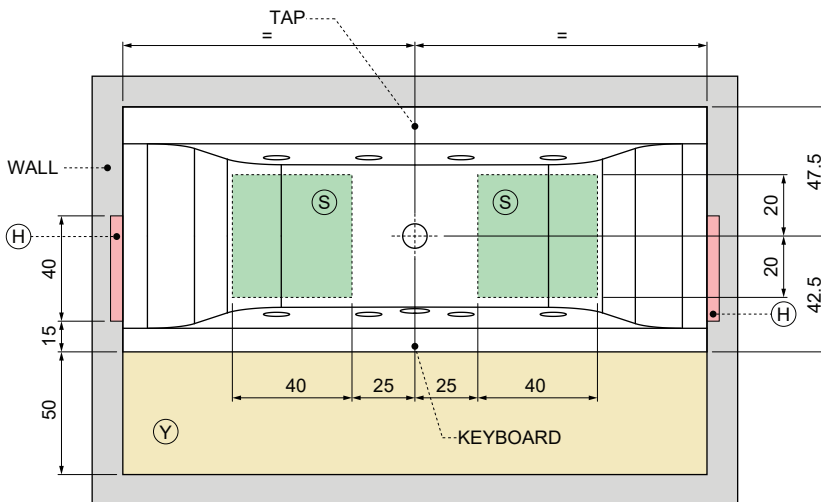

BUILT-IN WIRE

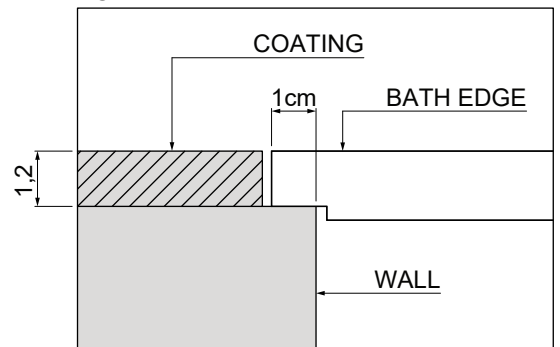

RECESSED IN SUPPORT

